



TUNGSRAM
Automotive Lamps

Contents

	page
Double Filament Asymmetric Halogen Headlight Lamps	2
Double Filament Asymmetric Traditional Headlight Lamps	4
Single Filament Halogen Headlight Lamps	5
Double Filament Stop and Tail Light Lamps	6
Single Filament Stop, Direction, Reverse and Fog Light Lamps	7
Tail, Parking, Indicator, Warning and Interior Lamps	8
Halogen Miniature Interior Lamps	11
Halogen Miniature Headlight Lamps for Bicycles and Scooters	11
Traditional Miniature Headlight Lamps for Bicycles and Scooters	11
Traditional Miniature Tail Lamps for Bicycles and Scooters	11
Spare Part Boxes	12
Which Lamp for Which Car?	13
Caps	19

General

GE Lighting TUNGSRAM offers one of Europe's largest ranges of vehicle lamps. Their superior quality is achieved by extensive use of the latest research and development with highly qualified technical personnel working in modern laboratories.

Our constant quality aim is Zero Defect. This goal involves designing quality into vehicle lamps which leads to suitability, quality and reliability as high as modern technology can make them.

Our lamps are manufactured to strict international standards and appropriately marked in conformance with E.C.E. regulations or with other Standards (DIN, ANSI).

Life is specified considering DIN 72601 and the I.E.C. Standard, respectively.

Rated Values refer to the values marked on the lamp.

Design Values refer to the values found at the test voltage in conformance with E.C.E. regulations and DIN Standard.

Type	ECE R37 Indication	Rated Values		Design Values		Life (hours)	Pack Qty.	Product Code	EAN Code 900410-
		Volts	Watts	Volts	Watts				

DOUBLE FILAMENT ASYMMETRIC HALOGEN HEADLIGHT LAMPS

Lamp Types According to ECE R37

Cap: P45t-41 52950	— Fig. 1 R2 Halogen	12	45/40	13.2	58/51	125/250	1/10/100	203110	—
Cap: PX43t 50460	— Fig. 2 HS1	6	35/35	6.3	35/35	100/200	1/10/100	203050	—
50470	HS1	12	35/35	13.2	35/35	100/200	1/10/100	203353	1033517
Cap: P43t-38 50440	— Fig. 2 H4	12	60/55	13.2	71/65	225/450	1/10/100 40/200 bulk	203504 203514	1035016 —
50440*	H4	12	60/55	13.2	71/66	225/900	1/10/100 40/200 bulk 1/20 blister	201317 201330 201320	1013113 — 1013212
50440 MU** Megalight	H4	12	60/55	13.2	75/68	150/300	1/10/100	201700	1017012
Cap: P43t-38 50440 BU***	— Fig. 3 Super-blue	H4	12	60/55	13.2	75/68	1/10/100	203800	1038017
50450	H4	24	75/70	28	80/73	150/300	1/10/100 40/200 bulk	207608 207610	1076019 —
Cap: P43t-38 70440	— Fig. 4 H4 yellow	12	60/55	13.2	71/65	225/450	1/10/100 40/200 bulk 1/20 blister	206403 206405 202783	1064016 — 1027813
Cap: P43t-38 70440/1****	— Fig. 5 H4 gold	12	60/55	13.2	71/66	225/900	1/10/100 40/200 bulk	201530 201535	1015315 1015315
70440/2U*****	H4 Allday	12	60/55	13.2	75/68	350/700	1/10/100	201632	1016312
Cap: P43t-38 70450	— Fig. 6 H4 yellow	24	75/70	28	80/73	150/300	1/10/100 40/200 bulk	208300 208305	— —

*In hard glass bulb.

**30% more light on the road at 75m in comparison with standard types.

***Bluish-white light (made of special blue glass); Availability: 2nd half of 1998.

****With selective yellow coating.

*****With Allday coating.

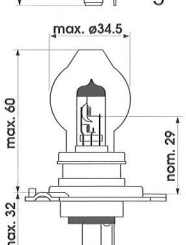
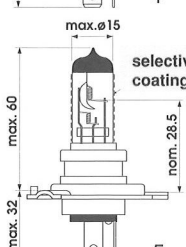
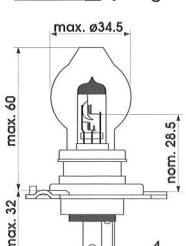
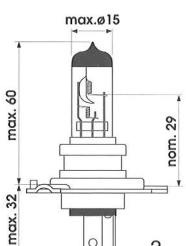
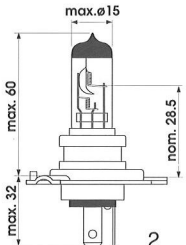
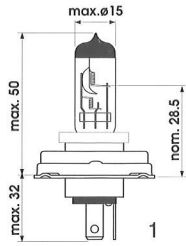

Type	ECE R37 Indication	Rated Values		Design Values		Life (hours)	Pack Qty.	Product Code	EAN Code 900410-
		Volts	Watts	Volts	Watts				

DOUBLE FILAMENT ASYMMETRIC HALOGEN HEADLIGHT LAMPS (continued)

Special Types, not included in ECE R37

Cap: P43t-38 — Fig. 1

52050	—	12	100/90CP**	13.2	71/65	150/300	1/10/100	204103	1041017
52090	—	12	100/55	13.2	100/65	100/200	1/10/100	204203	1042014
52100	—	12	100/80	13.2	100/80	100/200	1/10/100	204403	1044018
52650	—	12	35/35	13.2	35/35	100/200	1/10/100	204450	1044513
52670	—	12	140/100	13.2	140/100	25/50	1/10/100	203200	—
							40/200 bulk	204702	1047019
								204706	—

Cap: P43t-38 — Fig. 2

52710	—	24	100/70	28	100/73	100/200	1/10/100	207802	1078013
-------	---	----	--------	----	--------	---------	----------	--------	---------

Cap: P43t-38 — Fig. 3

72050 yellow	—	12	100/90 CP*	13.2	71/65	225/450	1/10/100	206702	—
72100 yellow	—	12	100/80	13.2	100/80	100/200	1/10/100	206903	—
72100/1U gold	—	12	100/80	13.2	100/80	100/200	1/10/100	204680	1046814

Cap: P45t-41 — Fig. 4

52020	—	12	100/55	13.2	100/65	100/200	1/10/100	205702	—
52030	—	12	100/80	13.2	100/78	100/200	1/10/100	205803	1058015
52040	—	12	100/90CP*	13.2	71/65	100/200	1/10/100	205607	1056011
52070	—	12	60/55	13.2	71/65	225/450	1/10/100	205207	1052013
52080	—	24	75/70	28	80/73	150/300	1/10/100	207903	1079010
52600	—	6	35/35	6.3	35/35	100/200	1/10/100	205002	—
52660	—	12	140/100	13.2	140/100	25/50	1/10/100	206002	—
52730	—	24	100/70	28	100/73	100/200	1/10/100	208103	—

Cap: P45t-41 — Fig. 5

72030 yellow	—	12	100/80	13.2	100/78	100/200	1/10/100	207503	—
72040 yellow	—	12	100/90CP*	13.2	71/65	225/450	1/10/100	207402	—
72070 yellow	—	12	60/55	13.2	71/65	225/450	1/10/100	207207	1072010
72080 yellow	—	24	75/70	28	80/73	150/300	1/10/100	207205	—
							40/200 bulk	208503	—

Cap: P36t — Fig. 6

52110	—	12	60/55	13.2	71/65	225/450	1/10/100	206204	—
-------	---	----	-------	------	-------	---------	----------	--------	---

* CP= candlepower.

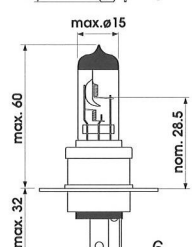
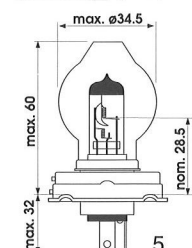
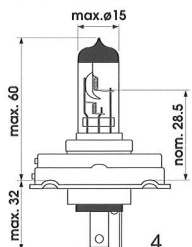
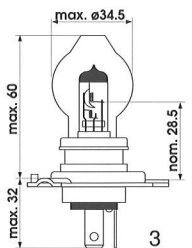
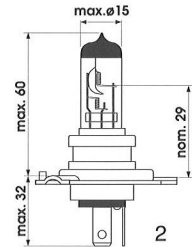
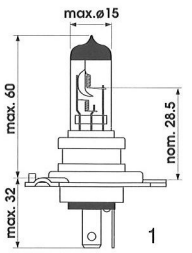

Type	ECE R37 Indication	Rated Values		Design Values		Life (hours)	Pack Qty.	Product Code	EAN Code 900410-
		Volts	Watts	Volts	Watts				

DOUBLE FILAMENT ASYMMETRIC TRADITIONAL HEADLIGHT LAMPS

Lamp Types According to ECE R37

Cap: P45t-41 — Fig. 1

1926	R2	6	45/40	6	45/40	75/150	1/10/100	224003	1240014
1931	R2	12	45/40	12	46/42	75/150	1/10/100	224154	1241516
							200 bulk	224165	-
							1/20 blister	224200	1242018

Cap: P45t-41 — Fig. 2

1937	R2	24	55/50	24	55/50	75/150	1/10/100	225003	1250013
							200 bulk	225008	-

Special Types, not included in ECE R37

Cap: P45t-41 — Fig. 1

1976	-	6	75/75CP*	6	55/50	100/100	1/10/100	224362	1243619
1981	-	12	75/75CP*	12	55/50	100/100	1/10/100	224453	1244517
							200 bulk	224455	-

Cap: P45t-41 — Fig. 2

1987	-	24	60/60CP*	24	75/75	100/100	1/10/100	225203	1252017
------	---	----	----------	----	-------	---------	----------	--------	---------

* CP= candlepower.

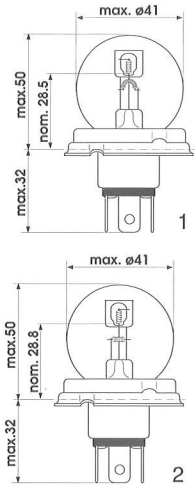

Type	ECE R37 Indication	Rated Values		Design Values		Life (hours)	Pack Qty.	Product Code	EAN Code 900410-
		Volts	Watts	Volts	Watts				

SINGLE FILAMENT HALOGEN HEADLIGHT LAMPS

Lamp Types According to ECE R37

Cap: PX26d — Fig. 1									
58520/U	H7	12	55	13.2	58	500	1/10/100	202960	1029619
58520 LU	H7	12	55	13.2	58	—	40/200 bulk	202962	—
							1/10/100	202940	1029411
							40/200 bulk	202942	—
Cap: P14.5s — Fig. 2									
50310/1	H1	12	55	13.2	64	800	1/10/100	200304	1003015
							150/300 bulk	200305	—
							1/10/100 blister	200523	1005217
50310*	H1	12	55	13.2	64	800	1/10/100	200037	1000311
50320/1	H1	24	70	28	80	600	150/300 bulk	200036	—
70310/1 gold	H1	12	55	13.2	64	800	1/10/100	200603	1006016
							150/300 bulk	200606	—
							1/10/100	200510	1005118
							150/300 bulk	200512	—
							1/10/100	200892	1008911
Cap: PK22s — Fig. 3									
50330	H3	6	55	6.3	55	150	1/10/200	208603	—
50340	H3	12	55	13.2	62	400	50/400 bulk	208605	—
							1/10/200	208803	1088012
							50/400 bulk	208814	—
							1/10/100 blister	208983	1089811
50340 HD	H3	12	55	13.2	62	400	1/10/100	208790	1087916
50350	H3	24	70	28	75	225	50/400 bulk	208792	—
							1/10/200	209703	1097014
							50/400 bulk	209706	—
							1/10/100 blister	209713	1097113
70340 U gold	H3	12	55	13.2	62	400	1/10/200	208590	1085912
							50/400 bulk	208592	—
							1/10/200	208552	1085516
Cap: P20d — Fig. 4									
53060 U	HB3	12	60	13.2	73.5	530	1/10/100	202420	1024218
9005	ANSI	12	65	12.8	70	14V/320	40/200	202422	—
Cap: P22d — Fig. 5									
53070 U	HB4	12	51	13.2	62	2000	1/10/100	202500	1025017
9006	ANSI	12	55	12.8	59	14V/1000	40/200	202502	—
Cap: X511 — Fig. 6									
50410	H2	12	55	13.2	65	225	1/10/200	200705	1007013
							100/400 bulk	200724	—
							1/10/100 blister	200813	1008119
50420	H2	24	70	28	78	150	1/10/200	201063	1010617
							100/400 bulk	201065	—

Special Types, not included in ECE R37

Cap: P14.5s — Fig. 2									
52140	—	12	100	13.2	100	100	1/10/100	200115	1001110
							150/300 bulk	200145	—
Cap: P14.5s/R — Fig. 2									
50370	—	12	100	13.2	100	100	1/10/100	200054	1000519
Cap: PK22s — Fig. 3									
50390	—	12	35	13.2	40	150	50/400 bulk	208705	—
50400	—	24	100	28	104	100	1/10/200	210003	1100011
							50/400 bulk	210005	—
52130	—	12	100	13.2	100	100	1/10/200	209103	1091012
							50/400 bulk	209105	—
							1/10/100 blister	209423	1094211
Cap: PK22s/A — Fig. 7									
52180	—	12	55	13.2	62	225	1/10/200	209203	1090015
							50/400 bulk	209205	—
52190	—	12	35	13.2	40	200	1/10/200	208754	—
Cap: PK22s/R — Fig. 3									
50360	—	12	100	13.2	100	100	1/10/200	209003	—
50380	—	24	100	28	104	100	1/10/200	209903	1099018
Cap: X511 — Fig. 6									
52150	—	12	100	13.2	100	100	1/10/200	200903	1009017
							100/400 bulk	200906	—

* With narrowed geometric tolerances.
 **With selective Allday coating.

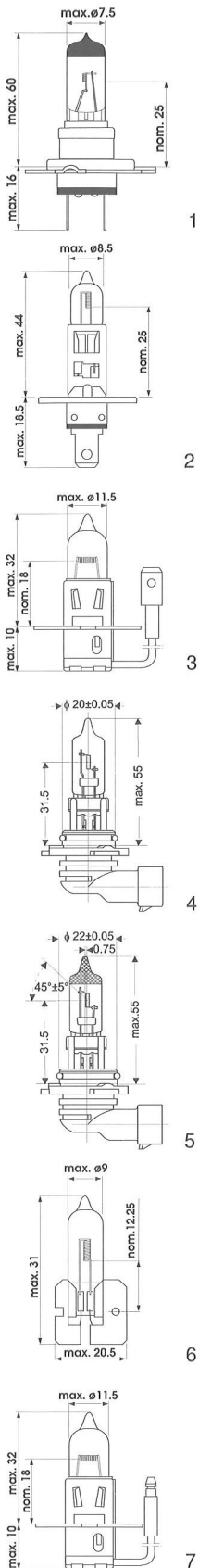

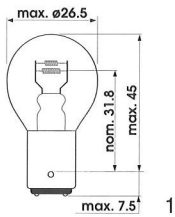

Type	ECE R37 Indication	Rated Values		Design Values		Life (hours)	Pack Qty.	Product Code	EAN Code 900410-
		Volts	Watts	Volts	Watts				

DOUBLE FILAMENT STOP AND TAIL LIGHT LAMPS

Lamp Types According to ECE R37

Cap: BAY15d — Fig. 1

1076	P21/5W	6	21/5	6.75	26/6	100/1000	10/200	222104	1221013
							100/1000 bulk	222106	-
1077	P21/5W	12	21/5	13.5	25/6	225/1800	10/200	222206	1222010
							1/10/200	222190	1221914
							100/1000 bulk	222209	-
							1000 bulk	222213	-
1077L*	P21/5W	12	21/5	13.5	25/6	550/2700	2/20/200 blister	222224	1222218
							10/200	222462	1224717
							1/10/200	222470	1224717
							100/1000 bulk	222463	-
1078	P21/5W	24	21/5	28	28/10	150/1500	2/20/200 blister	222490	-
							10/200	222625	1226216
							100/1000 bulk	222626	-

Cap: BAZ15d — Fig. 1

1122	P21/4W	12	21/4	13.5	25/5	225/1800	10/200	223300	1233016
							1000 bulk	223306	-

Special Types, not included in ECE R37

Cap: BA15d — Fig. 1

1074	-	12	18/5	13.5	18/5	75/200	10/200	222003	-
1098	-	12	20/5	13.5	20/5	75/200	10/200	223066	1230619
1124	-	24	18/5	28	20/7	75/200	10/200	223354	1233511

Cap: BAY15d — Fig. 1

1075	DIN 72601S**	12	18/5	13.5	18/5	75/200	10/200	222044	1220412
1089	-	6	20/5	6.75	20/5	75/200	10/200	223023	1230213
1099	-	12	20/5	13.5	20/5	75/200	10/200	223100	1231012
1101	-	12	25/7	13.5	25/7	75/200	10/200	223204	1232019
1126	DIN 72601S**	24	18/5	28	20/7	75/200	10/200	223402	1234013
1157	ANSI 1157**	12	32/3CP***	12.8/14	2.1/0.59A	600/2000	10/200	223506	1235010
							2/20/200 blister	223530	-

* L-lamps are krypton-filled.



** Other Standards.

*** CP= candlepower.

Type	ECE R37 Indication	Rated Values		Design Values		Life (hours)	Pack Qty.	Product Code	EAN Code 900410-
		Volts	Watts	Volts	Watts				

SINGLE FILAMENT STOP, DIRECTION, REVERSE AND FOG LIGHT LAMPS

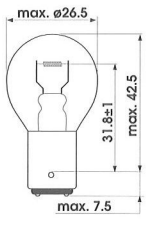
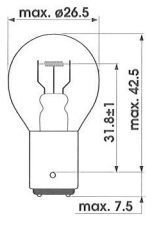
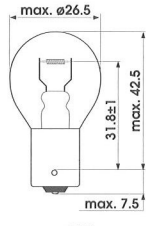
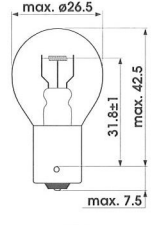
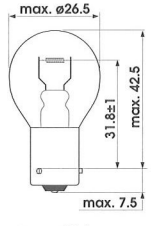
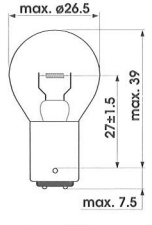
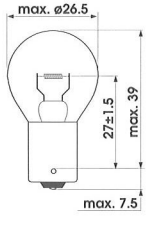
Lamp Types According to ECE R37

	Cap: BA15d — Fig. 1								
	1058 P21W	12	21	13.5	25	300	10/200	219703	1197011
	1061 P21W	24	21	28	28	150	100/1000 bulk	219705	-
	Cap: BA15d — Fig. 2								
	1061HD* P21W	24	21	28	28	150	10/200	220204	-
	Cap: BA15s — Fig. 3								
	1053 P21W	6	21	6.75	26	100	10/200	219004	1190012
	1057 P21W	12	21	13.5	25	300	100/1000 bulk	219007	-
	1057L** P21W	12	21	13.5	25	550	1/10/200	219180	1191811
	1060 P21W	24	21	28	28	150	1000 bulk	219216	-
	Cap: BA15s — Fig. 4								
	1060HD* P21W	24	21	28	28	150	100/1000 bulk	219213	-
	1056L** P21W	12	21	13.5	25	550	2/20/200 blister	219163	1191613
	1060 P21W	24	21	28	28	150	10/200	219510	1195116
	1060 P21W	24	21	28	28	150	10/200	219500	-
	Cap: BAU15s — Fig. 5								
	1056 amber PY21W	12	21	13.5	25	300	100/1000 bulk	219503	-
	1056L** amber PY21W	12	21	13.5	25	550	100/1000 bulk	219905	1199015
	1073 PY21W	24	21	28	28	150	100/1000 bulk	219907	-
	1073 PY21W	24	21	28	28	150	10/200	219932	1199312
	1073 PY21W	24	21	28	28	150	100/1000 bulk	219935	1199312
	1073 PY21W	24	21	28	28	150	100/1000 bulk	219935	-

Special Types, not included in ECE R37

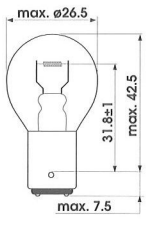
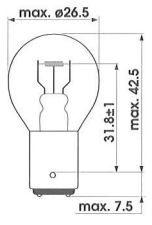
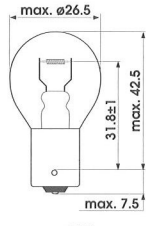
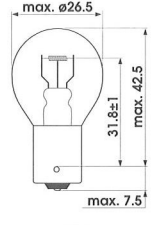
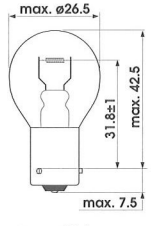
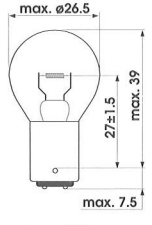
	Cap: BA15d — Fig. 6								
	1114 -	24	15	28	15	75	10/200	220363	1203613
	1116 -	24	18	28	20	75	10/200	220472	1204719
	1140 -	6	15	6.75	15	75	10/200	221102	-
	1142 -	12	15	13.5	15	75	10/200	221303	1213018
	Cap: BA15d — Fig. 1								
	1132 -	24	24	28	28	100	10/200	220652	1221013
	1135 -	28	26	28	28	100	100/1000 bulk	220912	-
	Cap: BA15s — Fig. 7								
	1055 DIN 72601R***	6	18	6.75	18	75	10/200	219114	1191118
	1059 DIN 72601R***	12	18	13.5	18	75	100/1000 bulk	219120	-
	1115 -	24	15	28	15	75	10/200	219818	1198117
	1117 DIN 72601R***	24	18	28	20	75	10/200	219816	-
	1141 DIN 72601F***	6	15	6.75	15	75	10/200	220404	1204016
	1143 DIN 72601F***	12	15	13.5	15	75	100/1000 bulk	220555	1205518
	Cap: BA15s — Fig. 3								
	1134 -	24	24	28	28	100	10/200	221164	-
	1137 -	28	26	28	28	100	100/1000 bulk	221166	-
	1156 ANSI 1156****	12	32CP****	12.8	2.1A	600	10/200	221366	1213612
	1137 -	28	26	28	28	100	100/1000 bulk	220753	1207512
	1137 -	28	26	28	28	100	100/1000 bulk	220762	-
	1137 -	28	26	28	28	100	100/1000 bulk	221010	-
	1156 ANSI 1156****	12	32CP****	12.8	2.1A	600	10/200	221502	1215012
	1156 ANSI 1156****	12	32CP****	12.8	2.1A	600	100/1000 bulk	221504	-

* Heavy-Duty lamps feature robust design with prolonged life under circumstances they must perform.

** L-lamps are krypton-filled.

*** Other Standards.

****CP= candlepower.

Type	ECE R37 Indication	Rated Values		Design Values		Life (hours)	Pack Qty.	Product Code	EAN Code 900410-
		Volts	Watts	Volts	Watts				

TAIL, PARKING, INDICATOR, WARNING AND INTERIOR LAMPS

IN SPHERICAL BULB

Lamp Types According to ECE R37

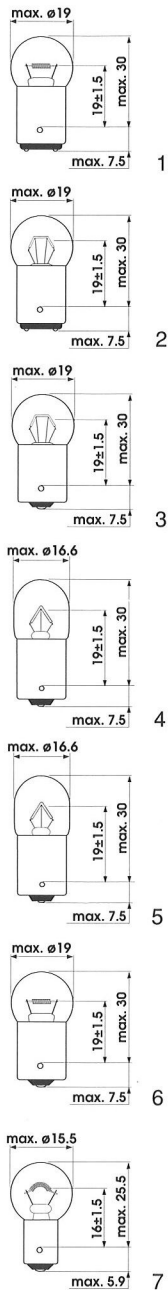

Cap: BA15d — Fig. 1										
2618	R5W	12	5	13.5	5	250	10/500	229736	1297315	
2640	R10W	12	10	13.5	10	400	100/1000 bulk	229737	—	
Cap: BA15d — Fig. 2										
2626	R5W	24	5	28	7	200	10/500	233242	1332412	
2626HD*	R5W	24	5	28	7	200	100/1000 bulk	233255	—	
2626HD*	R5W	24	5	28	7	200	10/500	233270	—	
2626HD*	R5W	24	5	28	7	200	100/1000 bulk	233260	—	
Cap: BA15s — Fig. 3										
2627	R5W	24	5	28	7	200	10/500	233402	1334010	
2627HD*	R5W	24	5	28	7	200	100/1000 bulk	233405	—	
2627HD*	R5W	24	5	28	7	200	1/10/200	233590	1335918	
2627HD*	R5W	24	5	28	7	200	10/500	233570	—	
2627HD*	R5W	24	5	28	7	200	100/1000 bulk	233620	—	
Cap: BA15s — Fig. 4										
2643	R10W	24	10	28	12.5	200	10/500	230438	1304310	
2643HD*	R10W	24	10	28	12.5	200	100/1000 bulk	230437	—	
Cap: BA15s — Fig. 5										
2643HD*	R10W	24	10	28	12.5	200	1/10/200	230450	1304518	
2643HD*	R10W	24	10	28	12.5	200	10/500	230440	1304419	
Cap: BA15s — Fig. 6										
2615	R5W	6	5	6.75	5	200	10/500	229633	1296318	
2619	R5W	12	5	13.5	5	300	100/1000 bulk	229635	—	
2619	R5W	12	5	13.5	5	300	10/500	229855	1298510	
2619	R5W	12	5	13.5	5	300	1/10/200	229840	1298411	
2619	R5W	12	5	13.5	5	300	100/1000 bulk	229860	—	
2619	R5W	12	5	13.5	5	300	2000 bulk	229863	—	
2619L**	R5W	12	5	13.5	5	650	2/20/200 blister	229904	1299012	
2619L**	R5W	12	5	13.5	5	650	1/10/200	230060	1300619	
2639	R10W	6	10	6.75	10	200	100/1000 bulk	230053	—	
2641	R10W	12	10	13.5	10	400	10/500	230133	1301319	
2641	R10W	12	10	13.5	10	400	100/1000 bulk	230135	—	
2641	R10W	12	10	13.5	10	400	10/500	230264	1302613	
2641	R10W	12	10	13.5	10	400	1/10/200	230280	1302811	
2641	R10W	12	10	13.5	10	400	100/1000 bulk	230268	—	
2641	R10W	12	10	13.5	10	400	2000 bulk	230267	—	
2641L**	R10W	12	10	13.5	10	650	2/20/200 blister	230294	1302910	
2641L**	R10W	12	10	13.5	10	650	10/500	—	—	

Special Types, not included in ECE R37

Cap: BA9s — Fig. 7										
2665	—	12	6	13.5	6	200	10/500	235142	1351413	
Cap: BA15s — Fig. 6										
67	ANSI 67***	12	4CP****	13.5	0.59A	2000	10/500	229883	1298817	
2609	—	12	3	13.5	3	200	100/1000 bulk	229882	—	
2609	—	12	3	13.5	3	200	10/500	229524	1295212	

* Heavy-Duty lamps feature robust design with prolonged life under circumstances they must perform.

** L-lamps are krypton-filled.

*** Other Standards.

****CP= candlepower.

Type	ECE R37 Indication	Rated Values		Design Values		Life (hours)	Pack Qty.	Product Code	EAN Code 900410-
		Volts	Watts	Volts	Watts				

TAIL, PARKING, INDICATOR, WARNING AND INTERIOR LAMPS

IN TUBULAR BULB

Lamp Types According to ECE R37

Cap: BA9s — Fig. 1										
2659	T4W	6	4	6.75	4	300	10/500	234142	1341414	
							500 bulk	234152	—	
2662	T4W	12	4	13.5	4	450	10/500	234702	1347010	
							1/10/200	234720	1347218	
							500 bulk	234719	—	
							8000 bulk	234717	—	
2662L*	T4W	12	4	13.5	4	900	2/20/200 blister	234695	1346914	
							1/10/200	234920	1349212	
							500 bulk	234913	—	
Cap: BA9s — Fig. 2										
2661	T4W	24	4	28	5	300	10/500	234402	1344019	
							500 bulk	234418	—	
							8000 bulk	234423	—	
Cap: BA9s — Fig. 3										
2661HD**	T4W	24	4	28	5	300	10/1000	234550	1345511	

Special Types, not included in ECE R37

Cap: BA7s — Fig. 4										
2690	DIN 72601J***	6	1.2	6.75	1.2	200	10/1000	235852	1358511	
Cap: BA7s — Fig. 5										
2692	DIN 72601J***	24	3	28	3	200	10/1000	235932	1359310	
							500 bulk	235942	—	
2696	DIN 72601J***	12	2	13.5	2	200	10/1000	236062	1360613	
							500 bulk	236072	—	
Cap: BA9s — Fig. 6										
2673	—	12	1.5	13.5	1.5	200	10/1000	235332	1353318	
2681	—	24	3	28	3	200	10/500	235502	1355015	
2697	—	12	3	13.5	3	200	10/500	236213	1362112	
Cap: BA9s — Fig. 7										
2656	—	12	3	13.5	3	200	10/500	233922	1339213	
							500 bulk	233927	—	
2657	DIN 72601H***	6	2	6.75	2	200	10/500	234002	1340011	
2660	DIN 72601H***	12	2	13.5	2	200	10/500	234262	1342619	
							500 bulk	234272	—	
2663	DIN 72601H***	24	2	28	3	200	10/500	235002	1350010	
							500 bulk	235009	—	
Cap: E10/13 — Fig. 8										
2683	—	12	3	13.5	3	200	10/500	235602	1356012	
							500 bulk	235612	—	
2688	—	24	3	28	3	200	10/500	235752	1357514	
							500 bulk	235762	—	

* L-lamps are krypton-filled.

** Heavy-Duty lamps feature robust design with prolonged life under circumstances they must perform.

*** Other Standards.

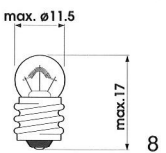
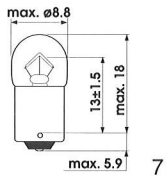
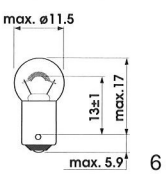
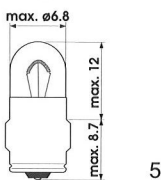
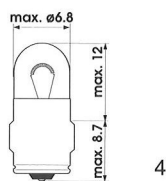
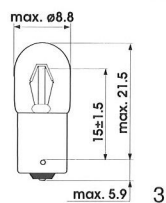
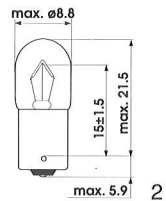
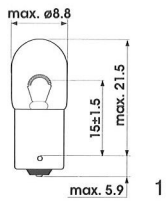

Type	ECE R37 Indication	Rated Values		Design Values		Life (hours)	Pack Qty.	Product Code	EAN Code 900410-
		Volts	Watts	Volts	Watts				

TAIL, PARKING, INDICATOR, WARNING AND INTERIOR LAMPS

WITH WEDGE CAP

Lamp Types According to ECE R37

Cap: W2x4.6d — Fig. 1

5301	W1.2W	12	1.2	13.5	1.2	1500	10/2000 4000 bulk 2/20/200 blister	237903 237905 237922	1379011 — 1379219
------	-------	----	-----	------	-----	------	--	----------------------------	-------------------------

Cap: W2.1x9.5d — Fig. 2

5304	W3W	12	3	13.5	3	1500	10/500 500 bulk	238064 238066	1380611 —
5307	W5W	12	5	13.5	5	450	2/20/200 blister 10/500 500 bulk 800/8000 bulk 2/20/200 blister	238122 238216 238215 238217 238205	1381212 1382110 — — 1382011

Special Types, not included in ECE R37

Cap: W2.1x9.5d — Fig. 2

5313	—	12	2	13.5	2	200	10/500 500 bulk	238353 238355	1383513 —
------	---	----	---	------	---	-----	--------------------	------------------	--------------

IN FESTOON FORM

Lamp Types According to ECE R37

Cap: SV8.5/8 — Fig. 3

7544	C5W	6	5	6.75	5	200	10/500 250 bulk	231332 231337	1313312 —
7546	C5W	12	5	13.5	5	450	10/500 1/10/200 250 bulk 5000 bulk	231432 231450 231437 231439	1314319 1314517 — —
7552	C5W	24	5	28	7	300	2/20/200 blister 10/500 250 bulk 5000 bulk	231424 231612 231617 231619	1314210 1316115 — —

Special Types, not included in ECE R37

Cap: SV8.5/8 — Fig. 4

7575	—	12	5	13.5	5	200	10/500 250 bulk	231832 231837	1318317 —
7576	DIN 72601K*	12	10	13.5	10	200	10/500 1/10/200 250 bulk 2/20/200 blister	231902 231920 231909 231892	1319017 1319215 — 1318911
7579	—	24	5	28	7	200	10/500	232072	1320716
7580	—	24	10	28	10	200	10/500	232162	1321614

Cap: SV8.5/8 — Fig. 5

7592	DIN 72601K*	12	15	13.5	15	75	10/500	232302	1323014
7593	—	12	18	13.5	18	75	10/500 250 bulk	232402 232406	1324011 —
7594	—	24	15	28	15	75	10/500	232512	1325117
7595	DIN 72601K*	24	18	28	20	75	10/500	232582	1325810

* Other Standards.

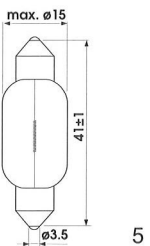
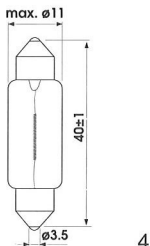
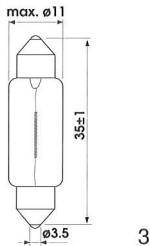
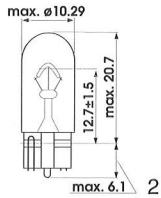
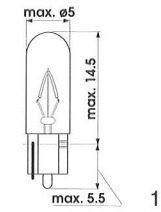

Type	ECE R37 Indication	Rated Values		Design Values		Life (hours)	Pack Qty.	Product Code	EAN Code 900410-
		Volts	Watts	Volts	Watts				

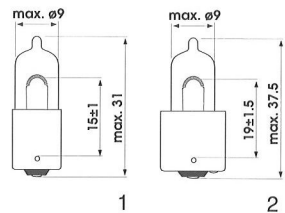

HALOGEN MINIATURE INTERIOR LAMPS

Cap: BA9s — Fig. 1										
58540	—	12	5	13.5	5	240	1/10/500	210903	1109014	
58560	—	12	10	13.5	10	240	500 bulk	210906	—	
Cap: BA15s — Fig. 2										
58570	—	12	5	13.5	5	240	1/10/500	211100	1111017	
58580	—	12	10	13.5	10	240	1/10/500	211200	1112014	
							250 bulk	211205	—	

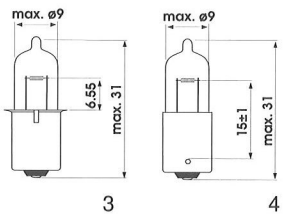

HALOGEN MINIATURE HEADLIGHT LAMPS FOR BICYCLES AND SCOOTERS

Lamp Types According to ECE R37

Cap: PX13.5s — Fig. 3										
58290	HS3	6	2.4	6	2.5	100	1/10/500	210702	—	
							500 bulk	210706	—	

Special Types, not included in ECE R37

Cap: BA9s — Fig. 4										
58240	—	6	3	6	3.1	100	1/10/500	210600	—	
Cap: EP10/14x11 — Fig. 5										
58170	—	6	2.4	6	2.5	100	1/10/500	210300	—	
							500 bulk	210303	—	
58180	—	6	3	6	3.1	100	1/10/500	210400	—	
Cap: PX13.5s — Fig. 3										
58300	—	6	3	6	3.1	100	1/10/500	210800	1108017	

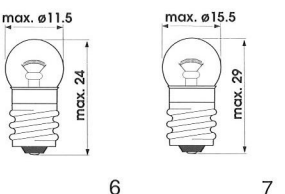
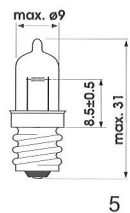

TRADITIONAL MINIATURE HEADLIGHT LAMPS FOR BICYCLES AND SCOOTERS

Cap E10/13 — Fig. 6										
2780	—	2.5	0.2A	2.5	0.2A	15	10/500	233000	1330012	
							500 bulk	233007	—	
2781	—	2.5	0.3A	2.5	0.3A	15	10/500	233050	1330517	
							500 bulk	233054	—	
2782	—	3.5	0.2A	3.5	0.2A	15	10/500	233080	1330814	
							500 bulk	233087	—	
2784	—	3.8	0.3A	3.8	0.3A	15	10/500	233160	1331613	
							500 bulk	233166	—	
Cap: E10/13 — Fig. 7										
2746	—	6	2.7	6	2.7	100	10/500	236610	1366110	
2747	—	6	3	6	3	100	10/500	236640	1366417	
							500 bulk	236634	—	
Cap: EP10/14x11 — Fig. 8										
2765	DIN 49848*	6	2.4	6	2.4	100	10/500	236790	1367919	
							500 bulk	236802	—	

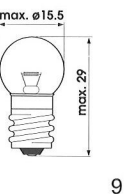

TRADITIONAL MINIATURE TAIL LAMPS FOR BICYCLES AND SCOOTERS

Cap: EP10/13 — Fig. 9										
2702	DIN 49848*	6	0.6	6	0.6	100	10/500	236320	1363218	
							500 bulk	236332	—	

* Other Standards.

Type	Pack Qty.	Product Code	EAN Code 900410-
------	-----------	--------------	------------------

AUTOMOTIVE LAMP SPARE PART BOXES

Spare Part Box with R2 Headlight Lamp	1	223972	1239711
- 1931 R2 double filament asymmetric traditional headlight lamp	1		
- 1057 auxiliary lamp	1		
- 1077 auxiliary lamp	1		
- 2619 auxiliary lamp	1		
- 2662 auxiliary lamp	1		
- 5307 auxiliary lamp	1		
- 7546 auxiliary lamp	1		
- 8A cylindrical fuse	1		
- 16A cylindrical fuse	1		
- 10A fuse	1		
- 15A fuse	1		
Spare Part Box with H4 Headlight Lamp	1	223982	1239810
- 50440 H4 double filament asymmetric halogen headlight lamp	1		
- 1057 auxiliary lamp	1		
- 1077 auxiliary lamp	1		
- 2619 auxiliary lamp	1		
- 2662 auxiliary lamp	1		
- 5307 auxiliary lamp	1		
- 7546 auxiliary lamp	1		
- 8A cylindrical fuse	1		
- 16A cylindrical fuse	1		
- 10A fuse	1		
- 15A fuse	1		

Car Type (Manufacturing Year)	Head-light Lamp	Fog Light Lamp	Park Lamp	Front	Blinkers Side	Back	Rear Light Lamp	Stop Lamp	Rear Fog Lamp	Reverse Indicator Lamp	Licence Plate Light	Interior Lamp
ALFA ROMEO												
Alfa 33,75,90 (1985-89)	H4		2662	1057	2662	1057	2619	1057	1057	1057	2619	7546
Alfa 33 (1989-)	H4	H3	2662	1057	2662	1057	1077	1057	1057	1057	2619	7546
Alfa 33 (-1990)	H4		2662	1057		1057	2619	1077		1057	2619	
Alfa 33 (1990-)	H4	H3	5307	1057		1057	2619	1057	1057	1057	2619	
Alfa 75 (1989-92)	H4		2662	1057	2662	1057	2619	1057	1057	1057	2619	7546
Alfa 155 (1993-)	H1	H1	5307	1057	5307	1057	1077	1077	1057	1057	5307	7576
Alfa 164 (1989-)	H4		2619	1057		1057	1057	1077		1057	2619	7576
Alfasud, Alfasud TI (1973-82)	H1		2662	1057		1057	2619	1057		1057	2619	7546
Alfasud GL (1981-82)	H1		2662	1057		1057	1077	1077	1057	1057	2619	7546
Alfasud GL, TI (1982-87)	H1		2662	1057	2662	1057	1077	1077	1057	1057	2619	7546
Alfasud Sprint (1978-89)	H1		2662	1057	2662	1057	2619	1057	1057	1057	2619	7546
Alfetta GT, 2.0, 1.8 (1976-84)	H1		2619	1057		1057	1077	1077		1057	2619	7546
Alfetta 2.0, 2.0 GLE 19(78-84)	H1		2662	1057		1057	2619	1057	1057	1057	2662	7546
Alfetta GTV 2000 (1978-81)	H1		2619	1057		1057	1077	1077		1057	2619	7546
Alfetta GTV (1982-87)	H1		2662	1057	2662	1057	1077	1077	1057	1057	2619	7546
Giulietta 1.9 (1978-84)	H4		2662	1057		1057	2619	1057		1057	2662	7546
Spider (1989-)			2619	1057		1057	2619	1057		1057	2619	7546
AUDI												
80 (1977-79)	H4		2662	1057	5307	1057	2619	1057	1057	1057	2641	7576
80 (1980-)	H4		2662	1057	5307	1057	2641	1057	1057	1057	5307	7576
80, 80L, 80LS (1976-)	1931/H4	2662	1057	5307	1057	1077	1077	1057	1057	7546	7576	
80GL, 80GT (1976-)	H1		2662	1057	5307	1057	1077	1077	1057	1057	7546	7576
80 Quattro (1981-86)	H4		2662	1057	5307	1057	1077	1077	1057	1057	5307	7576
Coupé GT (1982-89)	H1/H4		2662	1057		1057	2641	1057		1057	2641	7576
Quattro/Avant (1981-94)	H1/H4		2662	1057	5307	1057	2641	1057		1057	2641	7576
100, 100L, 100LS 1976-)	1931/H4	H3	2662	1057	1057	1077	1077		1057	2662	7576	
100GL (1975-76)	H1	H3	2662	1057		1057	1077	1077		1057	2662	7576
100S Coupé	H1		2662	1057		1057	2619	1057			7546	7576
100SE (1977-)	H4	H3	2662	1057		1057	2641	1057		1057	2641	7576
100/200 (1978-82)	H4	H3	2662	1057		1057	2619	1057	1057	1057	7576	7576
100/200 (1983-94)	H4	H3	2662	1057	5307	1057	1077	1077	1057	1057	7576	7576
A3 (1996)	H7/H1		5307	1056	5307	1057		1077	1057	1057		
A3 (1997-)	H7/H1		5307	1056	5307	1077	5307	1077	1057	1057	7546	7576
A4 (1995-)	H7		5307	1056	5307	1077	5307	1077	1057	1057	7546	7576
A6 (1995-)	H1	H3	5307	1056	5307	1057	2641	1077	1057	1057	2662	7576
A8 (1995-)	H1/MPXL/HB 3	H3	5307	1056	5307	1077	5307	1077	1057	1057	1057	7546
AUSTIN – see Leyland												
BMW												
Serie 300 (1976-81)	H4		2662	1057	2662	1057	2641	1057	1057	1057	7546	7576
Serie 300 (1982-90)	H1	H1	2662	1057	2662	1057	2641	1057	1057	1057	7546	7576
Serie 500 (1988-95)	H1	H1	2662	1057	2662	1057	2619	1057	1057	1057	7546	7576
Serie 700 (1988-94)	H1		2662	1057	2662	1057	2619	1057	1057	1057	7546	7576
Serie 6 (E24) (1980-89)	H1	H3	2662	1057		1057	2619	1057	1057	1057	7546	
850i (1989-)	H1	H1	1077	1057		1057	2619	1057	1057	1057	7546	
Serie 3 (1995-)	H7	H1	5307	1057	5307	1057	2619	1057	1057	1057	7546	7576
Serie 5 (1996-)	H7/HB 3	H7	5307	1057		1057	2619	1057	1057	1057	7546	7546
Serie 7 (1995-)	H7/H1	H3	5307	1057		1057	2619	1057	1057	1057	7546	7546
Z3	H7/HB 3	H7	5307	1057		1057	2619	1057	1057	1057	7546	
Compact	HB 4/HB 3	H1	5307	1056	5307	1056	1077	1077	1057	1057	7546	
CHEVROLET												
Camaro (1978-79)	H4		1077	1077		5304	1077	1077		1057		
Caprice (1979-)	H4		1077	1077		1077	1077	1077		1057	5304	4592
Citation (1980)	H4		1077	1077		1057	1077	1077		1057	5304	4545
CHRYSLER												
Voyager	H4		2662	1057	5307	1057	2641	1057	1057	1057	5307	
Neon (1995-)	H4		2662	1057	2662	1057	1077	1077	1057	1057	5304	7546
Stratus (1995-)	H4	HB 4	2662	1056	2662	1057	1077	1077	1057	1057	5304	7546
CITROËN												
2CV/Dyane 1981-90)	1931		2662	1057		1057	2619	1057	1057		2619	2619
AX (1986-)	H4	H3	2662	1057		1057	2619	1057	1057	1057	2662	7575
Saxo (1997-)	H4	H1	5307	1056	5307	1056	1077	1077	1057	1057	5307	5307
Visa (1979-88)	H4		2662	1057	5307	1057	2619	1057	1057	1057	2619	7576
Visa GTI (1984-88)	H1		2662	1057	5307	1057	2619	1057	1057	1057	2619	7576
C15, C15D (1986-91)	1931		2662	1057		1057	1077	1077	1057	1057	2641	7546
GS (1980-87)	H4		2619	1057		1057	2619	1057	1057	1057	2619	7546
ZX Reflex, Advantage (1991-96)	H4		2619	1057	5307	1057	2619	1077	1057	1057	2619	2619
ZX Aura, Volcane (1991-96)	H1	H3	2619	1057	5307	1057	2619	1077	1057	1057	2619	2619
BX (1982-93)	H4	H2	2662	1057		1057	2619	1057	1057	1057	2619	7546
CX (1979-91)	H4		2619	1057		1057	1077	1077	1057	1057	2619	7546
CX25 GTI Turbo (1984-91)	H4	H2	2619	1057		1057	1077	1077	1057	1057	2619	7546
Xantia (1994-97)	H1	H3	5307	1057	5307	1057	1077	1077	1057	1057	5307	5307
XM (1989-91)	H1	H3	2619	1057	5307	1057	2619	1077	1057	1057	2619	7546
XM (1992-)	H1	H3	2619	1057	5307	1057	2619	1077	1057	1057	5307	5307

Car Type (Manufacturing Year)	Head-light Lamp	Fog Light Lamp	Park Lamp	Front	Blinkers Side	Back	Rear Light Lamp	Stop Lamp	Rear Fog Lamp	Reverse Indicator Lamp	Licence Plate Light	Interior Lamp
DAIHATSU												
Applause (1989-93)	H4		5307	1057	2619	1057	1077	1077	1057	1057	5307	7576
Charade (1979-80)	1931		2619	1057	2619	1057	1077	1077	1057	1077	2641	7585
Charade (1980-82)	H4		2619	1057	2619	1057	1077	1077	1057	1077	2641	7585
Charade (1983-94)	H4		5307	1057	2619	1057	1077	1077	1057	1077	2641	7585
Charmani (1982-83)	H4		2619	1057	2619	1057	1077	1077	1057	1077	2619	7546
DATSUN – see Nissan												
FIAT												
Brava/Bravo (1995-)	H1	H1	5307	1057		1057	2619	1057	1057	1057		
Croma (1986-94)	H4	H3	2619	1057	5307	1057	2619	1057	1057	1057	2619	7546
126 Ibis (1984-91)	1931		2662	1057		1057	1077	1077	1057	1057	5307	7546
Cinquecento (1997-)	H4		5307	1056	5307	1057	1057	1077	1077	1057	7546	
127 (-1978)			2662	1057		1057	1077	1077	1057	7546	7546	7546
127/Fiorino (1979-88)	H4		2619	1057		1057	1077	1077		1057	2619	7546
127/Fiorino (1988-93)	H4		5304	1057	5307	1057	1077	1077	1057	1057	2619	7546
Panda (1983-93)	1931		2662	1057	5307	1057	1077	1077	1057	1057	7546	7546
Punto (1994-)	H1/H4	H3	5307	1056	5307	1056	2619	1057	1057	1057	7546	
Regatta (1983-90)	H4		5304	1057	5307	1057	1077	1077	1057	1057	2619	7546
Ritmo (1983-88)	H4	H1	5307	1057	5307	1057	1077	1077	1057	1057	7546	7546
Uno (1982-89)	H4		5307	1057	5307	1057	2619	1057	1057	1057	5307	7546
Uno (1990-94)	H4		5304	1057		1057	2619	1057	1057	1057	5307	7576
Tipo, Tempra (1988-94)	H4		5307	1057		1057	2619	1057	1057	1057	7546	7546
131 Mirafiori (1980-84)	H1		2619	1057		1057	2619	1057	1057	1057	2619	7576
Argenta XI/9 (1977-89)	H4		2619	1057		1057	2619	1057	1057	1057	2619	7546
FORD												
Ka (1997-)	H7/H1		5307	1057	5307	1057	2619	1057	1057	1057	5307	
Fiesta (1983-89)	H4	H3	2662	1057		1057	1077	1077	1057	1057	2641	2641
Fiesta (1996-)	H7/H1	H1	5307	1057	5307	1057	2619	1057	1057	1057	2641	2641
Escort, Orion (1986-90)	H4	H3	2662	1057	2662	1057	1077	1077	1057	1057	5307	2641
Escort, Orion (1990-)	H4	H3	5307	1057	2662	1057	2619	1057	1057	1057	2641	2641
Galaxy (1995-)	H4	H1	5307	1056	5307	1056	1077	1077	1057	1057	5307	7576
Sierra (1982-87)	H4	H3	5307	1057		1057	1077	1057	1057	1057	5307	2641
Sierra (1988-93)	H4	H3	5307	1057		1057	1122	1057	1122	1057	5307	2641
Scorpio, Granada (1985-)	H4	H3	5307	1057	2662	1057	2641	1057	1057	1057	5307	7576
Mondeo (1993-)	H1/H7	H3	5307	1057		1057	1077	1057	1057	1057	5307	7576
Explorer (1993-)	H4		5307	1056	2619	1056	1077	1077	1077	1077	7546	
FORD USA												
Mustang (1974-79)	H4		1077	1077		1077	1077	1077			7538	2641
HONDA												
Civic (1980-83)	H4		2619	1057	5307	1057	1077	1077		1057	2619	7546
Civic (1984-87)	H4		2619	1077		1057	1077	1057	1057	1057	2619	7585
Civic (1988-)	H4		5307	1077		1057	1077	1077		1057	2619	7585
Accord (1977-81)	1931		2619	1057		1057	1077	1077		1057	2641	7546
Accord (1982-85)	H4		1077	1077		1057	1077	1077		1057	2619	7585
Accord (1986-93)	H4		5307	1077		1057	2619	1057		1057	2619	7585
Accord (1994-)	H1		5307	1056		1057	1077	1077	1057	1057	5307	7585
Legend (1988-92)	H4		5307	1077		1057	1077	1077		1057	2619	7585
Prelude (1988-96)	H4	H3	5307	1077		1057	1077	1077		1057	2619	7585
HYUNDAI												
Accent (1995-)	H4			1057		1057	1077	1077		1057	2619	7576
Elantra (1993-)	H4		5307	1057	5307	1057	1077	1077		1057	2619	7576
Pony (1992-94)	H4		2662	1057		1057	1077	1077		1057	2619	7576
Sonata (1993-)	H4		5307	1057	5307	1057	1077	1077		1057	2619	7576
JAGUAR												
Jaguar XJ-6 11 (1976-77)	1931		2619	1057	2662	1057	1077	1077	1057	7593	5307	7546
Jaguar XJ-12 11 (1975-)	H4		2619	1057	2662	1057	2619	1077	1057			
Jaguar XJS (1978-83)	H1		2619	1057	2662	1057	2619	1057	1057		7546	7546
Jaguar XJS (1984-)	H4		2662	1057	5307	1057	2619	1057	1057		7546	7546
Jaguar XJS 2.9, 3.6, 4.0 (1986-)	H4		2619	1057	5307	1057	2619	1057	1057	1057	7546	7576
J6/12 (1981-88)	H4		2662	1057	5307	1057	2619	1057	1057	1057	2662	
KIA												
Sephia (1994-)	H4			1057		1057	1077	1077	1057	1057		
LADA												
Samara (1987-)	H4		2662	1057	2662	1057	2619	1057	1057	1057	2619	7546
Niva (1989-)	H4		2662	1057	2662	1057	2619	1057	1057	1057	2619	7546
Niva 1700 (1996-)	H4		2619	2662	1057	1057	2619	1057	2619	2619	5304	

Car Type (Manufacturing Year)	Head-light Lamp	Fog Light Lamp	Park Lamp	Front	Blinkers Side	Back	Rear Light Lamp	Stop Lamp	Rear Fog Lamp	Reverse Indicator Lamp	Licence Plate Light	Interior Lamp
LANCIA												
Y 10 (1988)	H4		5307	1057	5307	1057	1077	1077	1057	1057	2665	7546
600 (1984-86)	H4		2662	1057	5307	1057	1057	1057	1057	1057	2662	7546
Beta 1800-2000 (1974-78)	H1		2619	1057	2662	1057	1077	1077		1057	2665	7546
Kappa (1994-)	H7	H3	5307	1057		1057	2619	1077	1057	1057	5307	
Prisma (-1986)	H4		2662	1057	5307	1057	1057	1057	1057	1057	2662	7546
Delta (1986-89)	H4		2662	1057	2662	1057	2619	1057	1057	1057	2662	7546
Gamma (1975-85)	H1		2619	1057	2662	1057	2619	1057	1057	1057	2662	7546
Dedra (1989-)	H4		2619	1057	2662	1057	2619	1057	1057	1057	7546	7546
Thema (1985-89)	H4		5307	1057	2662	1057	2619	1057	1057	1057	5307	7546
LEYLAND												
Mini (1976-)	1931		5307	1057	2662	1057	1057	1057	1057		7546	7546
Maestro, Montego (1983-85)	H4		2662	1057		1057	5307	1077	1057	1057	2662	
Maestro, Montego (1986-)	H4		5307	1057		1057	5307	1077	1057	1057	2662	
Princess (1976-78)	H4		2662	1057	5307	1057	1077	1077	1057	1057	5307	7546
MAZDA												
121 (1988-91)	H4		2619	1057	2619	1057	1077	1077	1057	1057	2619	
323 (1981-88)	H4		5301	1057	5307	1057	1077	1077	1057	1057	2619	
323 (1989-96)	H4		2619	1057	2619	1057	1077	1077	1057	1057	2619	7546
626 (1981-91)	H4		2619	1057	2619	1057	1077	1077	1057	1057	2619	
626 (1992-)	H1/H3		2619	1057	5307	1057	1077	1077	1057	1057	2662	
929 (192-88)	H4		2619	1057	2619	1057	1077	1077	1057	1057	2662	
MX3 (1991-)	H4	H3	5307	1057		1057		1077	1057	1077	5307	
MX5 (1989-)	H4	H3	5307	1057		1057	1077	1077	1057	1057	5307	
MX6 (1994-96)	H1	H1	5307	1057		1057		1077	1057	5307	5307	
RX7 (1987-)	H4		2619	1057	5307	1057	1077	1077	1057	1057	2619	
MERCEDES-BENZ												
190 E, D (1984-93)	H4	H3	2662	1057		1057	2641	1057	1057	1057	7546	7576
C 180 (1996-)	H1/H7	H3/H1	5307	1056	5307	1056	2619	1057		1057	7546	
C 180 kombi (1996-)	H1/H7	H3/H1	5307	1056		1056	2619	1057		1057	7546	
200, 220, 230 E/CE, 290, 300 E/CE, 320 (1982-)	H4	H3	2662	1057		1057	2641	1057	1057	1057	7546	7576
210 (1996-)	H7			1057		1057	1122	1122	1057	2619	2619	
200 D, 250 D, 300 D, 200, 230, 300 TE (1982-)	H4	H3	2662	1057		1057	2641	1057	1057	1057	7546	7576
250, 250 C, 280 (1974-)	H4	H3	2662	1057		1057	2641	1057	1057	1057	7546	7576
E 200, E 420 (195-)	H7	H1		1056		1057		1122	1057	1057	5307	
E 200, E 421 kombi (1995-)	H7	H1		1056		1056		1122	1057	1057	5307	
300SL/500SL (1989-)	H1	H1	2662	1057		1057	1122	1057	1122	1057	7546	
300SE/600SL (1991-)	H4	H1	2662	1057		1057	2619	2619	2619	2619	7546	
MITSUBISHI												
Carisma (1995-97)	H4	H3	2662	1057	5307	1057	1077	1077	1057	1057	5307	7585
Colt (1993-)	H4	H3	5307	1057	5307	1057	5307	1077	1057	1057	5307	7585
Lancer sedan (1993-)	H4	H3	2662	1057	5307	1057	1077	1077	1057	1057	5307	7585
Lancer kombi (1993-)	H4	H3	2662	1057	5307	1057	1077	1077	1057	1057	5307	7585
Lancer HB (1993-)	H4	H3	2662	1057	5307	1057	5307	1077	1057	1057	5307	7585
Galant (1993-)	H4	H3	5307	1057	5307	1057	1077	1077	1057	1057	5307	7585
3000 GT (1993-)	H4	H1	5307	1057	5307	1057	1077	1077	1057	1057	5307	7585
Pajero (1992-)	H4		5307	1057	5307	1057	1077	1077	1057	1057	2641	7576
Cosmos (1991-)	H1		5307	1057	5307	1057	1077	1077	1057	1057	2641	7585
Space Runner/Wagon (1992-)	H4		5307	1057	5307	1057	1077	1077	1057	1057	2662	
NISSAN												
Almera (1996-)	H4		5307	1057	5307	1057	1077	1077	1057	1057	5307	
Bluebird (1982-90)	H4		2619	1057	5307	1057	1077	1077	1057	1057	5307	7576
Sunny (1982-)	H4		5307	1057	5307	1057	1077	1077	1057	1057	2641	7576
Sunny (1991-)	H4		5307	1057	5307	1057	1077	1077	1057	1057	5307	7576
Cherry/Laurel (1982-86)	H4		2619	1057	5307	1057	1077	1077	1057	1057	2641	7576
Datsun 280ZX (1982-83)	H4		2619	1057		1057	2619	1057	1057	1057	2641	7576
Micra (1983-)	H4		2619	1057	5307	1057	1077	1077	1057	1057	5307	5307
Micra (1993-)	H4		5307	1057	5307	1057	2619	1057	1057	1057	5307	7546
Prairie (1983-87)	H4		2619	1057	5307	1057	1077	1077	1057	1057	5307	5307
Maxima (1991-)	H4		2619	1057		1057	1077	1077	1057	1057	2619	7546
Primera (1991-)	H4		2619	1057		1057	1077	1077	1057	1057		7546
Serena (1994-)	H4		5307	1057	5307	1057	2619	1077	1057	1057	5307	
Stanza (1982-86)	H4		2619	1057		1057	1077	1077	1057	1057	2619	7546
Pickup (1982-93)	H4		1077	1077		1057	1077	1077	1057	1057	5307	7576

Car Type (Manufacturing Year)	Head-light Lamp	Fog Light Lamp	Park Lamp	Front	Blinkers Side	Back	Rear Light Lamp	Stop Lamp	Rear Fog Lamp	Reverse Indicator Lamp	Licence Plate Light	Interior Lamp
OPEL												
Corsa A (1983-92)	H4		2662	1057	5307	1057	1077	1077	1057	1057	2641	7576
Corsa B (1992-97)	H4	H3	5307	1057	5307	1057	1077	1057	1057		5307	7546
Kadett C Caravan/Coupé (1974-77)	H4		2662	1057		1057	1077	1077	1057	1057	2641	7538
Kadett D. E (1980-)	H4		2662	1057	5307	1057	1077	1077	1057	1057	2641	7576
Astra (1992)	H4	H3	5307	1057		1057	1077	1077	1057	1057	7576	7576
Ascona B (1976-81)	H4		2662	1057	5307	1057	1077	1077	1057	1057	2641	7576
Ascona C (1982-88)	H4		2662	1057	5307	1057	1077	1077	1057	1057	2641	7576
Vectra (1989-95)	H4	H3	5307	1057		1057	1077	1057	1122	1057	2641	7576
Vectra B (1995-)	H7/H1	H1	5307	1077	5307	1077	2619	1057	1122	1057	2641	7576
Calibra (1991-)	H1	H3	5307	1057		1057	2619	1057	1057	1057	7546	7576
Manta B (1976-)	H4		2662	1057		1057	1077	1077		1057	2641	7576
Rekord E, Senator, Monza (1978-86)	H4		2662	1057		1057	1077	1077		1057	2641	7576
Omega (1987-)	H4		5307	1057	5307	1057	1077	1077	1057	1057	2641	7576
Omega B (1994-)	H7/H1	H3	2662	1057	5307	1056	1077	1077	1057	1057	2641	7576
Omega Stationcar (1994-)			5307	1057	5307	1056	1077	1057	1056	1057	7546	
Commodore B (1972-77)	H4		2662	1057		1057	1077	1077		1057	2662	7576
Tigra	H1		5307	1056		1057	2619	1057	1122	1057	2641	
PEUGEOT												
104 (1973-83)	H4		2619	1057		1057	1077	1057			2619	7576
106 (1992-97)	H4	H3	2619	1057		1057	2619	1077	1057	1057	2619	7576
205 (1984-92)	H4		5307	1057	2662	1057	2619	1057	1057	1057	2619	
305 (1978-87)	H4		2619	1057	2662	1057	2619	1057	1057	1057	2619	7546
306 (1993-)	H4	H3	2662	1057	2662	1057	2619	1077	1057	1057	2619	7576
306 XN/XR (1993-)	H4	H3	5307	1057	2662	1057	1077	1077	1057	1057	2619	7576
306 XT/XSi (1993-94)	H1	H3	5307	1057	5307	1057	1077	1077	1057	1057	5307	7576
306 XT/XSi (1995-)	H7	H3	5307	1057	5307	1057	1077	1077	1057	1057	5307	7546
309 (1987-91)	H4		5307	1057	2662	1057	2619	1057	1057	1057	2619	7576
309 (1992-)	H4	H3	5307	1057	2662	1057	2619	1077	1057	1057	2619	7576
405 (1988-91)	H4	H1	2662	1057	2662	1057	2619	1057	1057	1057	2619	7546
405 (1992-)	H4	H3	2662	1057	2662	1057	2619	1077	1057	1057	2619	7546
405 BREAK (1992-)	H4	H3	2662	1057	2662	1057	1077	1077	1057	1057	2619	7546
406 (1996-)	H7	H1	5307	1056	5307	1057	2619	1077	1057	1057	5307	7546
504, 505 (1976-91)	H4		2619	1057	2662	1057	2619	1057	1057	1057	2619	7576
604 (1977-82)	H4		2619	1057		1057	2619	1057		1057	2619	7576
605 (1989-94)	H1	H3	2662	1057		1057	2619	1057	1077	1057		
605 (1995-)	H7	H1	5307	1056	5307	1057	2619	1077	1077	1057	5307	
PORSCHE												
911 (1977-)	H4	H3	2662	1057		1057	1077	1077	1057	1057	2662	7576
928 (1978-)	H4	H3	2662	1057		1057	2641	1057	1057	1057	7546	7576
944 (1982-)	H4		2662	1057		1057	2619	1057	1057	1057	2662	7576
924 - 944/S - S2 Turbo	H4	H3	2662	1057		1057	2619	1057	1057	1057	2662	
968 (1992-)	H4/H1	H3		1057		1057	1077	1077	1057	1057	2619	
993	H1/H3	H3	2662	1056	7546	1057	1077	1077	1057	1057	7546	
993 (1995-)	H1/MPXL/H3	H3	2662/5307	1057	7546	1057	1077	1077	1057	1057	7546	
RENAULT												
Clio (1990-)	H4		2619	1057	2660	1057	1077	1077	1057	1057	7546	7546
Espace (1984-)	H4		2619	1057	2660	1057	1077	1077	1057	1057	7546	7546
Laguna (1994-)	H1	H1	5307	1057	5307	1057	1077	1077	1057	1057	7546	7546
Megane (1996-)	H4		5307	1057	5307	1056	2619	1057	1057	1057	7546	7546
Megane Coupé (1996-)	H1		5307	1057	5307	1056	2619	1077	1057	1057	7546	
Fuego (1980-85)	H4		2662	1057	2660	1057	2619	1077	1057	1057	7546	7546
R4 (1977-78)	1931/H4		1077	1077	2660	1057	1077	1077	1057	2619	7546	
R5 TS TL (1976-77)	H4		2619	1057	2660	1057	1077	1077		1057	2619	7546
R5 GTS (1980-)	H4		2619	1057		1057	1077	1077		1057	2619	7546
R12 TS STV (1976-77)	H4		2619	1057	2660	1057	1077	1077		1057	2619	7546
R14 (1977-78)	H4		2619	1057	2660	1057	1077	1077		1057	2619	7546
R16 (1977-78)	H4		2619	1057	2660	1057	1077	1077		1057	2619	7546
R16 (1978-80)	H4		2619	1057		1057	1077	1077		1057	7546	7546
R18 6TL-TL-TS (1978-)	H4		2619	1057		1057	1077	1077		1057	7546	7546
19310 TL-TS (1978-)	H4		2619	1057	2660	1057	1077	1077		1057	7546	7546
R18 TL-TS-R18STV (1980)	H4		2619	1057		1057	1077	1077		1057	7546	7546
R19 (1988-)	H4		5304	1057	2660	1057	1077	1077		1057	7546	7546
19310 TL-TS (1980-)	H4		2619	1057	2660	1057	1077	1077		1057	7546	7546
19310-R30 (1976-81)	H4		2619	1057	2660	1057	1077	1077		1057	2619	7546
19315 (1984-)	H4		2662	1057	2660	1057	1077	1077		1057	7546	7546
R25 (1984-)	H4		2662	1057	2660	1057	1077	1077		1057	7546	7546
Twingo (1993)	H4		2619	1057	2660	1057	1077	1077		1057	7546	7546

Car Type (Manufacturing Year)	Head-light Lamp	Fog Light Lamp	Park Lamp	Front	Blinkers Side	Back	Rear Light Lamp	Stop Lamp	Rear Fog Lamp	Reverse Indicator Lamp	Licence Plate Light	Interior Lamp
ROVER												
Rover 3500 (1977-)	H4		2619	1057	5307	1057	2662	1057	1057	1057	7546	7546
Range Rover (1980-94)	H4		2662	1057		1057	1077	1077	1057	1077	2662	
Range Rover (1994-)	H4	H4	2619	1057		1057		1077	1057	1077	5307	
Range Rover Vogue (1982-94)	H4	H3	2619	1057		1057		1057	1057	1077		
Rover 213-216 (1984-86)	H4		2662	1057	5307	1057	1077	1077	1057	1057	5307	
Rover 213-216 (1987-)	H4		5307	1057	5307	1057	1077	1077	1057	1057	5307	
Rover 800 (1986-)	H4		5307	1057	5307	1057	1077	1077	1057	1057	5307	
Rover 214-216 (1990-)	H4		2662	1057	5307	1057	1077	1077	1057	1057		
Rover 200-400 (1990-)	H4		5307	1057	5307	1057	5307	1057	1057	1057	5307	7546
Rover 200-400 (1995-)	H7	H1	5307	1056	5307	1056	5307	1057	1057	1057	7546	
Rover 600 (1994-)	H1	H3	5307	1057	5307	1057	1077	1077	1057	1057	5307	
Rover 820 (1992-)	H4		5307	1057	5307	1057	5307	1077	1057	1057	5307	2619
SAAB												
99, 900 (1977-78)	H4		1077	1057	5307	1057	2619	1057	1057	1057	2619	7546
900 (1979)	H4		1077	1077		1057	2619	1057	1057	1057	7546	7546
900, 90 (1980-86)	H4		1077	1077	5307	1057	2619	1077	1057	1057	2619	7546
900, 900 CAB (1987-93)	H4		2619	1057	5307	1057	1077/2619	1057/1077	1057	1057	7546	7546
900 (1994-)	H4	H3	5307	1056	5307	1056	2619/1077	1077	1057	1057	2619	7576
9000 (1986-87)	H4		1077	1077	5307	1057	2619	1057	1057	1057	7546	7576
9000 CC (1988-)	H4		1077	1077	5307	1057	1122/2619	1057	1122	1057	7546	7546
9000 CD (1988-)	H4	H3	2619	1057	5307	1057	1122/2619	1057	1122	1057	7546	7546
9000 CD (1992-)	H4		1077	1077		1057	2619	1057	1122	1057	7546	7576
9000 CD (1995-)	H1		2662	1056		1056	2619	1077	1057	1057	7546	7576
9000 CS (1992-)	H1	H3	2662	1057	5307	1057	1122/2619	1057	1122	1057	2662	7576
9-May (1997-)	H7	H1	5307	1056	5307	1056	1077	1077	1057	1057	5307	7546/7576
SEAT												
Ibiza (1993-)	H4		2662	1057		1057	1077	1077	1057	1057	2662	7576
Toledo (1991-)	H4		2662	1057		1057	1077	1077	1057	1057	5307	7576
Cordoba (1994-)	H4	H3	2619	1057		1057	1077	1077	1057	1057	5307	7576
SIMCA/TALBOT												
1100-1100S* (1974)	1931		2619	1057		1057	2619	1057		1057	2619	2662
1100 Combi (1974)	1931		2619	1077		1077	1077	1077		1057	2619	2662
1100-1100LS Snecil (1974)	1931		2619	1057		1057	2619	1057		1057	2619	2662
1100 Horizon (1975-80)	H4	H3	2619	1057		1057	1077	1077		1057	2619	7546
1100 VF2 (1977)	1931	H3	2619	1057		1057	1077	1077		1057	2619	7546
1300-1500 Combi (1971-)	1931		1075	1075		1143	1075	1075			2619	7546
1501* (1971-)	1931		2619	1143		1143	2619	2619			2619	7546
1501 Combi* (1971-)	1931		2619	1143		1143	2619	2619			2619	7546
1307 GLS (1976-80)	H4		2662	1057		1057	1077	1077		1057	7546	7546
1508S (1976-80)	H4		2662	1057		1057	1077	1077		1057	7546	7546
1508GT Matra Rancho (1971-86)	H4		2619	1057		1057	1077	1077		1057	2619	7546
Simca 1.1 Samba (1978-86)	H4		2662	1057		1057	1077	1077		1057	2619	7546
Solara (1979-86)	H4		2662	1057		1057	1077	1077		1057	2619	7546
Tagora (1981-84)	H4		2662	1057		1057	1077	1077		1057	2619	7546
* or H3 on the Snecil model												
ŠKODA												
Škoda 105, 120 (1984-91)	H4		2662	1057		1057	2619	1057	1057	1057	261	7546
Favorit (1989-)	H4	H3	2662	1057	5307	1057	2641	1057	1057	1057	2662	7546
Felicia (1995-)	H4	H3	5307	1056	5307	1056	2619	1077	1057	1057	5307	7546
Octavia (1997-)	H4	H3	5307	1056	5307	1057	2619	1057	1057	1057	5307	
SUBARU												
Justy (1987-88)	H4		2662	1057	2662	1057	1077	1077	1057	1057	5307	7546
Justy (1989-)	H4		5307	1057	2662	1057	1077	1077	1057	1057	5307	7546
1600/1800 (1979-91)	H4		2619	1057	2662	1057	1077	1077	1057	1057	5307	7546
Legacy (1990-)	H4		2641	1057	2662	1057	2619	1057	1057	1057	2641	7576
Impreza (1993-)	H4		2641	1057	2662	1057	2619	1057	1057	1057	2641	7576
SUZUKI												
Alto (1980-86)	1931		2619	1057	5307	1057	1077	1077	1057	1057		7546
Alto (1987-91)	1931		2619	1057	5307	1057	1077	1077	1057	1057	2619	7546
Baleno (1995-)	H4		5307	1057	5307	1057	1077	1077	1057	1057	5307	7546
SJ410SA413 (85-)	H4		2619	1057	5307	1057	1077	1077	1057	1057	2641	7546
Swift (1984-89)	H4	H3	5307	1057	5307	1057	1077	1077	1057	1057	2619	7546
Swift/Vitara (1988-)	H4		5307	1057	5307	1057	1077	1077	1057	1057	7546	7546

Car Type (Manufacturing Year)	Head-light Lamp	Fog Light Lamp	Park Lamp	Front	Blinkers Side	Back	Rear Light Lamp	Stop Lamp	Rear Fog Lamp	Reverse Indicator Lamp	Licence Plate Light	Interior Lamp
TOYOTA												
Starlet (1985-)	H4		5307	1057			1057	1077	1077	1057	5307	7576
Corolla (1984-)	H4		5307	1057			1057	1077	1077	1057	5307	7576
Corolla (1992-)	H4		5307	1057	2619		1057	1077	1077	1057	5307	7576
Corolla Sedan (1992-)	H4		5307	1057	2619		1057	1077	1077	1057	2641	7576
Carina (1984-)	H4		5307	1057	2619		1057	1077	1077	1057	5307	7576
Carina E (1992-)	H4		5307	1057	2619		1056	1077	1077	1057	5307	7546
Camry (1984-)	H4		5307	1057	2619		1057	1077	1077	1057	5307	7576
Lexus	H4	H3	5307	1057			1057	2619	1057	1057	5307	
VOLKSWAGEN												
1300/02/03 (1968-75)	1931		2662	1057			1057	1077	1077		1143	2641 7576
1600 (1970-73)	1931/H4	2662	1057		1057		1077	1077		1057	2641	7576
411, 412 (1970-73)	H1		2662	1057			1057	1077	1077		1267/1143	2641 7576
Caravelle	H4		2662	1057			1057	2641	1057			2662 7576
Coach	H4		2662	1057			1057	2641	1057			2662 7576
Golf (1975-84)	1931/H4	H3	2662	1057			1057	2619	1057		1057	2662 7576
Golf (1984-)	H4	H3	2662	1057			1057	2619	1057	1057	1057	2662 7576
Golf (1995-)	H4	H3	2662	1056			1057	2619	1057	1057	1057	2662 7576
Golf Cabriolet (1979-)	H4	H3	2662	1057			1057	2619	1057	1057	1057	2662 7576
Golf Cabriolet (1984-)	H4	H3	2662	1057			1057	2619	1057	1057	1057	2662 7576
Jetta (1979-)	H4		2662	1057			1057	2619	1057		1057	2662 7576
K 70 (1971-)	1931		2661	1057			1057	2619	1057		1267/1057	2662 7576
2T (1977-)	H4	H3	2662	1057			1057	1077	1077		1057	2662
2T Pick Up (1977-)	H4	H3	2662	1057			1057	2641	1057		1057	2662
Passat (1981-88)	H4	H3	2662	1057			1057	1077	1077	1057	1057	2662 7576
Passat (1988-)	H4	H3	2662	1057			1057	2619	1077	1057	1057	2662 7576
Passat 2.2S (1973-)	H4	H3	2662	1057			1057	1077	1077		1057	2662 7576
Passat TS, GLS (1978-)	H4	H3	2662	1057			1057	1077	1077		1057	2662 7576
Passat (1997-)	H1/H7	H1	5307	1057	5307		1057	2619	1077	1057	1057	5307 7576
Polo-Polo Couri (1982-)	H4	H3	2662	1057			1057	1077	1057		1057	2662 7576
Polo Classic (1982-)	H4	H3	2662	1057			1057	1077	1077		1057	2662 7576
Polo (1995-)	H4	H3	2662	1056			1057	1077	1077	1057	1057	2662 7576
Santana (1982-88)	H4	H3	2662	1057			1057	2619	1057	1057	1057	2662 7576
Scirocco GTS/GTI/GTL/GTX (1981-86)	H4	H3	2662	1057			1057	2641	1057		1057	2662 7576
Scirocco (1986-)	H4	H3	2662	1057			1057	2641	1057	1057	1057	2662 7576
Vento (1993-)	H4	H3	2662	1057			1057	2619	1057	1057	1057	2662 7576
Taro (1989-)	H4	H3	2662	1057			1057	1077	1077	1057	1057	2662 7576
Transporter (1979-90)	H4	H3	2662	1057			1057	2619	1057		1057	2662 7576
Transporter (1991-)	H4	H3	2662	1057			1057	1077	1077		1057	2662 7576
Transporter Pick Up (1991-)	H4	H3	2662	1057			1057	2641	1057		1057	2662 7576
VOLVO												
Amazon (1961-70)	1931		2619	1057			1057	1077	1077		1057	7546 7576
142/144 (1967-71)	1931		7546	1057			1057	2619	1057		1057	7546 7576
142/144 (1972)	1931		7546	1057			1057	1099	1099		1057	7546 7576
142/144 (1973-74)	H4		7546	1057			1057	1077	1077		1057	7546 7576
242/244/245/264/265 (1975-78)	H4		1077	1077L/1157			1057	2619	1057		1057	7546 7576
244, 240 (1979-91)	H4		1077	1057	5307		1057	2619	1057	1057	1057	2662 7576
245, 240 (1979-91)	H4		1077	1057	5307		1057	2619	1057	1057	1057	7546 7592
264/265 (1977-91)	H4		1077	1057			1057	2619	1057		1057	7546
343, 345 (1976-91)	H4		2662	1057			1057	2619	1077		1057	2641 7546
340, 360 (1983-91)	H4		2662	1057	5307		1057	2641	1077	1057	1057	5307 2619
440, 460, 480 (1988-)	H4		1077	1057	5307		1057	5307	1057		1057	7546 7576
740/760/780 (1981-91)	H4		1077	1057	5307		1057	2619	1057	1057	1057	2662 7576
940/960 (1991-)	H4	H3	2619	1057	5307		1057	2619	1057	1057	1057	5307 5307
960 (1995-)	H4	H3	2619	1056	5307		1056	2619	1057	1057	1057	5307
850 (1992-)	H4	H3	2619	1057	5307		1057	2619	1057	1057	1057	5307 5307
850 (1995-)	H1	H3	2619	1057			1057	2619	1057	1057	1057	5307 5307
850 HGV (1993-)	H4	H3	2619	1057	5307		1057	1122	1057	1057	1057	5307 5301
900 (1994-)	H4	H3	2619	1057	5307		1057	2619	1057	1057	1057	5307 5307
S 70 (1996-)	H7	H1	5307	1056	5307		1056	2619	1057	1057	1057	5307 5307
V 70 (1996-)	H7	H1	5307	1056	5307		1056	2619	1122	1057	1122	5307 5307
C 70 (1996-)	H7	H1	5307	1056	5307		1056	2619	1057	1057	1057	5307 5307
S 40 (1996-)	H4	H3	2662	1056	5307		1056	2619	1057	1057	1057	7546 5307
V 40 (1996-)	H4	H3	2662	1056	5307		1056	2619	1057	1057	1057	7546 5307

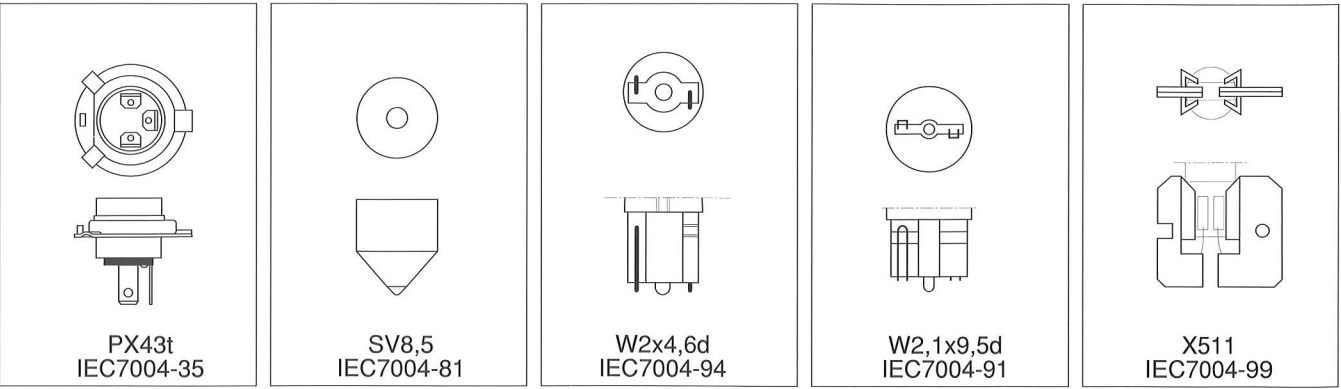
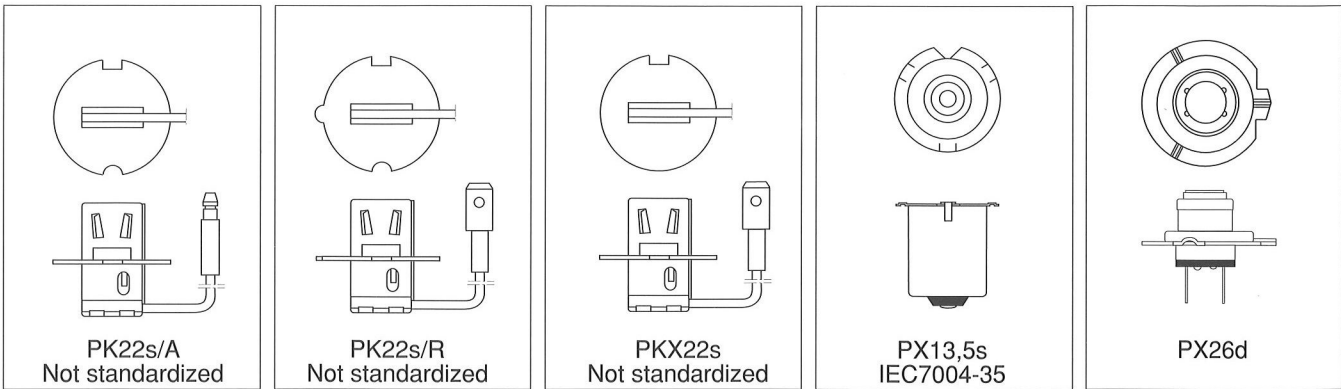
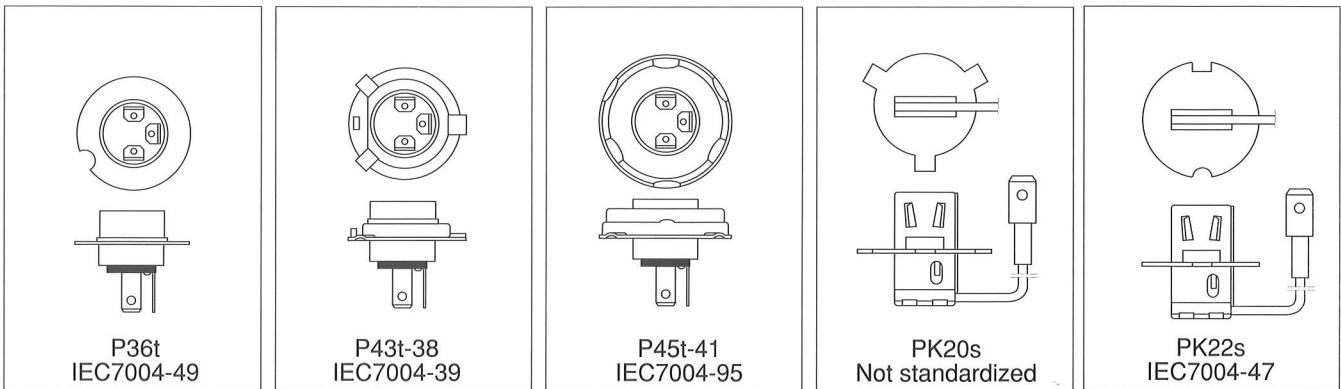
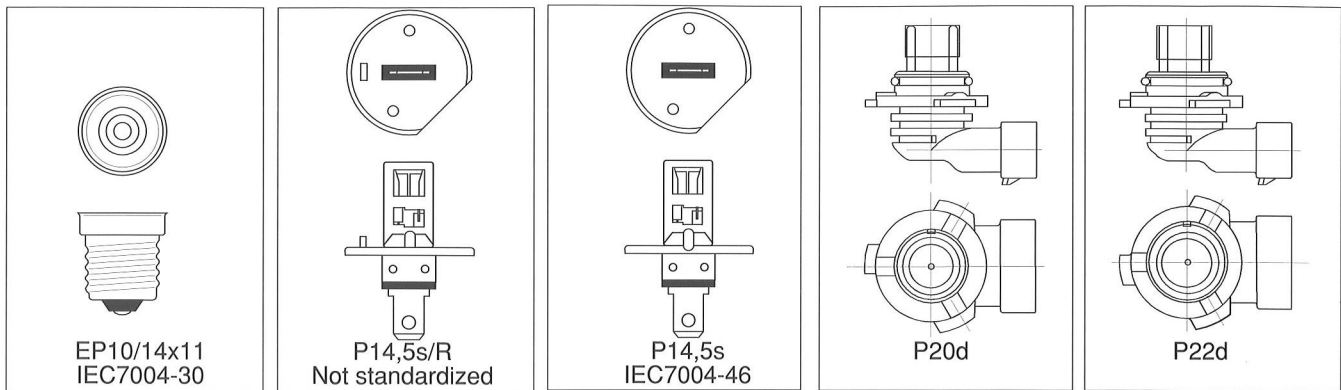
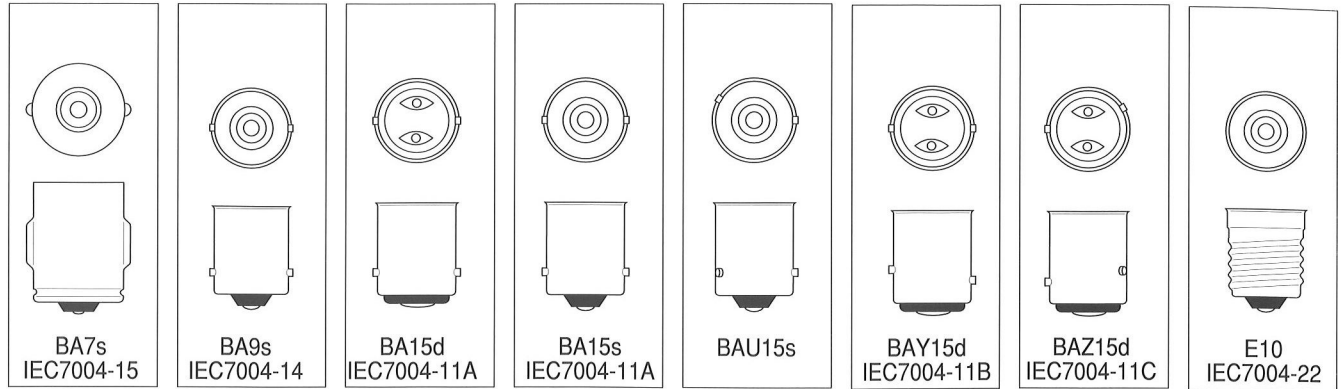

	page		page		page
1					
1053	7	2782	11	7	
1055	7	2784	11	70310/1 gold	5
1056 amber	7			70310/1/2U	5
1056L amber	7	5		70340 U gold	5
1057	7	50310	5	70340/2U	5
1057L	7	50310/1	5	70440	2
1058	7	50320/1	5	70440/1 (in hard glass bulb)	2
1059	7	50330	5	70440/2U	2
1060	7	50340	5	70450	2
1060HD	7	50340 HD	5	72030 yellow	3
1061	7	50350	5	72040 yellow	3
1061HD	7	50360	5	72050 yellow	3
1073	7	50370	5	72070 yellow	3
1074	6	50380	5	72080 yellow	3
1075	6	50390	5	72100 yellow	3
1076	6	50400	5	72100 yellow	3
1077	6	50410	5	7544	10
1077L	6	50420	5	7546	10
1078	6	50440	2	7552	10
1089	6	50440 (in hard glass bulb)	2	7575	10
1098	6	50440 BU	2	7576	10
1099	6	50440 MU	2	7579	10
1101	6	50450	2	7580	10
1114	7	50460	2	7592	10
1115	7	50470	2	7593	10
1116	7	50470	2	7594	10
1117	7	52020	3	7595	10
1122	6	52030	3		
1124	6	52040	3	9	
1126	6	52050	3	9005	5
1132	7	52070	3	9006	5
1134	7	52080	3		
1135	7	52090	3		
1137	7	52100	3		
1140	7	52110	3		
1141	7	52130	5		
1142	7	52140	5		
1143	7	52150	5		
1156	7	52180	5		
1157	6	52190	5		
1926	4	52600	3		
1931	4	52650	3		
1937	4	52660	3		
1976	4	52670	3		
1981	4	52710	3		
1987	4	52730	3		
		52950	2		
2		5301	10		
2609	8	5304	10		
2615	8	53060 U	5		
2618	8	5307	10		
2619	8	53070 U	5		
2619L	8	5313	10		
2626	8	58170	11		
2626HD	8	58180	11		
2627	8	58240	11		
2627HD	8	58290	11		
2639	8	58300	11		
2640	8	58520/U	5		
2641	8	58520 LU	5		
2641L	8	58540	11		
2643HD	8	58560	11		
2643	8	58570	11		
2656	9	58580	11		
2657	9				
2659	9	6			
2660	9	67	8		
2661	9				
2661HD	9				
2662	9				
2662L	9				
2663	9				
2665	8				
2673	9				
2681	9				
2683	9				
2688	9				
2690	9				
2692	9				
2696	9				
2697	9				
2702	11				
2746	11				
2747	11				
2765	11				
2780	11				
2781	11				

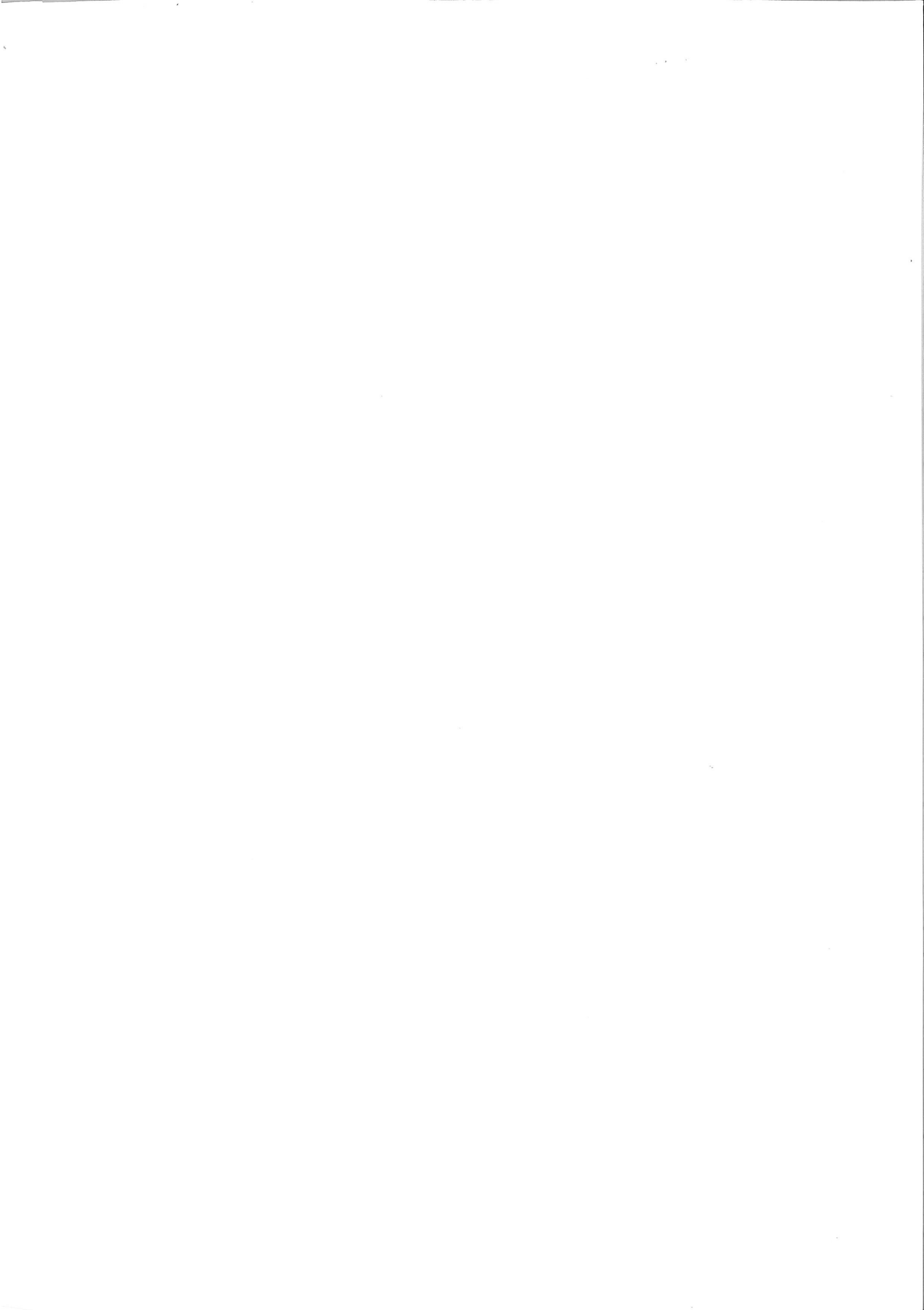

GE Lighting TUNGSRAM Rt.
H-1340 BUDAPEST, Váci út 77.
Hungary
Tel.: (361)169-2800
Fax: (361)169-2868